

phyCORE®-RK3288

Get your phyCORE®-RK3288 powered up and connected in just a few simple steps.

1) Preparing the Hardware

1. Check the kit content (see overview on the right hand side).
2. Have your connection cables at hand: You need an RS-232 cable (one-to-one) and a standard Ethernet cable.
3. Power up the phyCORE-RK3288. Connect the 2-pin PHOENIX connector to a 5 V (±5 %) DC power supply. Please note the polarity of the connectors (see picture). Or connect the power adapter (+5 V DC) to the power supply connector (X43).
4. The LEDs will light up.

Kit Contents

phyCORE®-RK3288 RDK

Power Adapter +5 V

RS-232 Cable

Removal tool

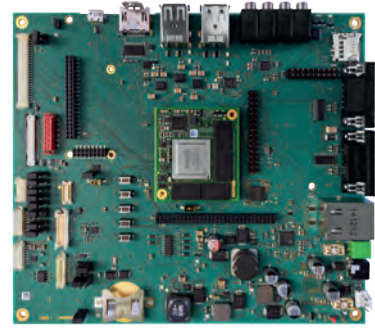

Ethernet Cable

USB flash drive with Virtual Machine

Documentation



Optional Accessories

Displays

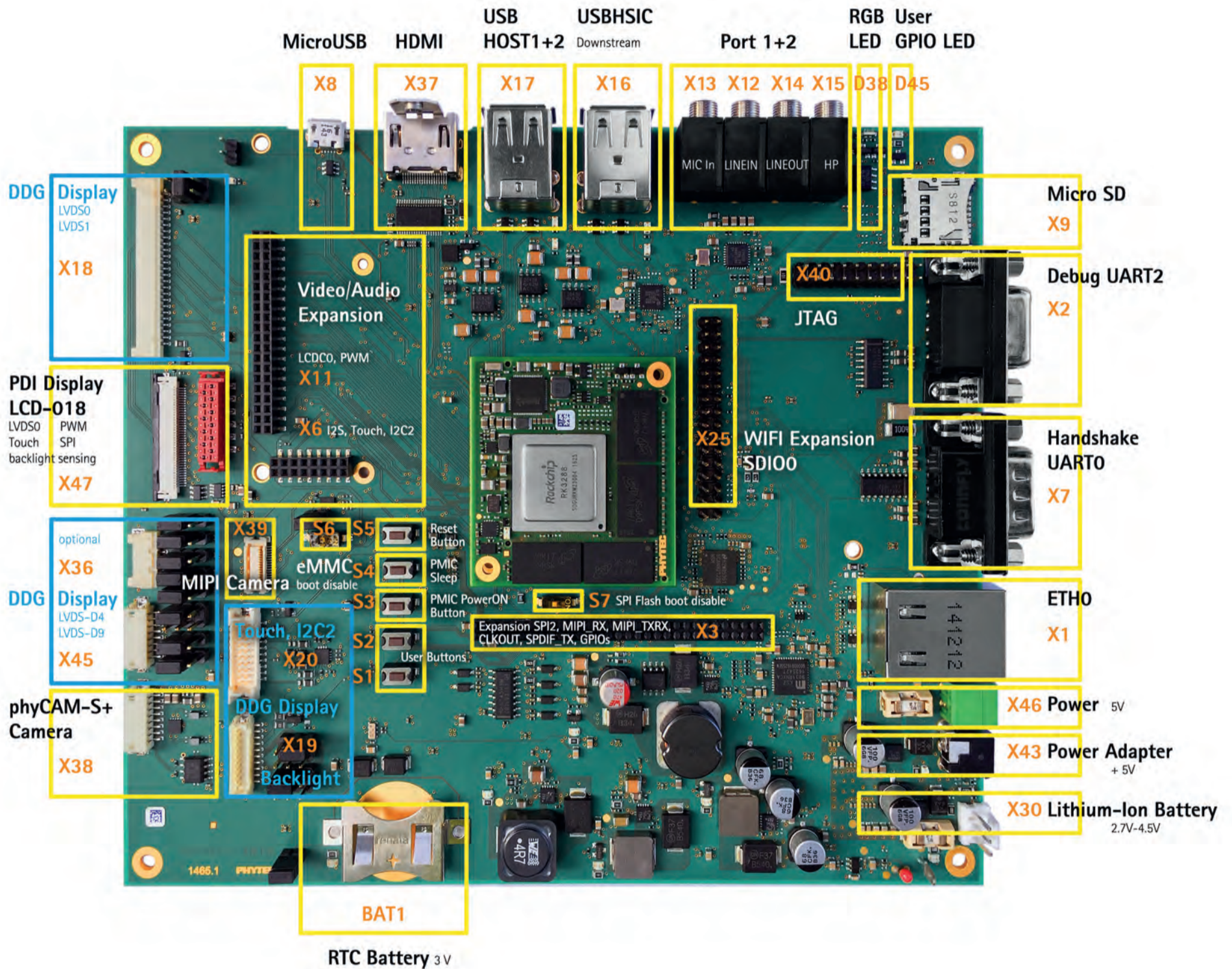
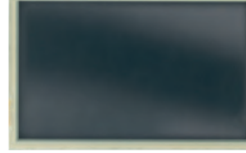

PHYTEC

Germany
PHYTEC Messtechnik GmbH
D-55129 Mainz
t +49 6131 9221-32
f +49 6131 9221-33
www.phytec.de
www.phytec.eu

France
PHYTEC France SARL
F-72140 Sillé le Guillaume
t +33 2 43 29 22 33
f +33 2 43 29 22 34
www.phytec.fr

USA
PHYTEC America LLC
Bainbridge Island, WA 98110
t +1 206 780 9047
f +1 206 780 9135
www.phytec.com

India
PHYTEC Embedded Pvt. Ltd.
Koramangala
Bangalore 560095
t +91 80 408670-46/49
www.phytec.in

China
PHYTEC Information Technology Co. Ltd.
Nanshan District, Shenzhen
518026 PRC
t +86 755 6180 2110
www.phytec.cn

L-841e_1

Quick Start Guide

2) Preparing and Starting the Virtual Machine

To follow this QuickStart and the descriptions in the VM manual you need our **phyCORE-RK3288 virtual machine hard disk image** which is stored on the delivered USB flash drive in a compressed archive (SO-545v1.zip). The hard disk image includes all software installations and configurations (e.g. Toolchain, Eclipse, Qt Creator) necessary for a successful start-up of the phyCORE-RK3288. The virtual machine hard disk image (.vmdk) is suitable for most virtualization software and can be mounted to an appropriate virtual machine (tested with VMware Player and Virtualbox).

1. **Plug-in the USB flash drive** into your host system
2. **Unpack** the compressed file with an appropriate tool to get the included **.vmdk file**
3. Follow the instructions of your virtualization software to create a new virtual machine. Pay regard to the following settings required to obtain a correctly working virtual machine:
 - choose **Linux-Ubuntu 64-bit version** as operating system
 - use the unpacked file **SO-545v1.vmdk** as existing hard disk
 - an Ethernet adapter, as well as a serial interface, or the USB controller must be available to connect to the phyCORE-RK3288

We recommend to have two network adapters available on the host pc. One for a peer-to-peer connection to the target and one with access to the internet, otherwise be advised that you will need to swap Ethernet connections multiple times in order to access documentation and sources.

4. Start the virtual machine with our hard disk image. You will see the modified Ubuntu desktop (A). For further use of the virtual machine the pre-created login data is:
username: phym - password: phyttec

Now you are ready to connect your PC with the phyCORE-RK3288.

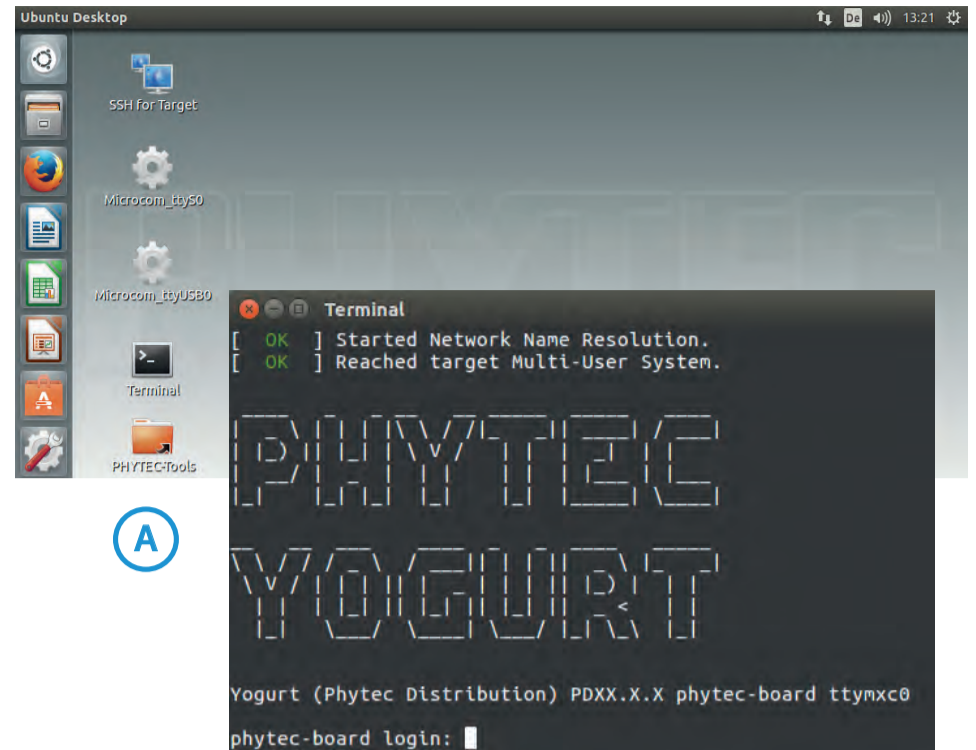

3) Getting Connected

Serial connection

1. Connect one end of the serial cable to the DB-9 connector (X2 UART2 RS232) on the board.
2. Connect the other end to the first serial interface of your PC (or to an USB to DB-9 dongle, connected to your host).
3. Click the **Microcom_ttySO icon (B)** on the Ubuntu desktop (for direct serial interface connection) or click the **Microcom_ttyUSB0 icon** if you are using a USB to DB-9 dongle.

 By default every input and output is transmitted over the serial connection with a baud rate of 115200.

4. Click the reset button on the board (or power off and on the board).

A serial console has been started within your Live System.

You should see a boot message and the login-prompt on this console (C). Congratulations!

 If you do not see any output in the Microcom window, check the serial connection between the target and your host. By default Microcom uses /dev/ttySO. If you want to use another port you can click on the Microcom Icon at your desktop with your right mouse button and select Properties. A window opens in which you can change the properties of the Microcom icon. Click in the Command field and search for „-p/dev/ttySO“. Change it for example to /dev/ttyS1 and so on if you have more than one serial port. If the Microcom window does not open, one reason could be a lock-file which was created when Microcom was not correctly terminated. Delete this file by opening a terminal and type: **sudo rm /var/lock/LCK..***

5. Use "root" as the log-in-name on the serial console (and press enter).
6. As a good example (and helpful for understanding the next step) enter **ifconfig**. You will get information about the configuration of the Ethernet interface of the target (D).

Ethernet connection

We recommend disconnecting your host-PC from any other network, because a peer to-peer connection from your PC to the phyCORE-RK3288 will be established.

1. Connect your preferred Ethernet interface on your PC with RJ45 connector **X1 (ETH0)** on the **phyCORE-RK3288** using a standard Ethernet cable.
2. Configure the IP-settings on your host platform in Ubuntu:
 - In the **Unity-panel** (left side of your desktop) click on the **Ubuntu logo** (topmost icon).
 - The Ubuntu dashboard will open; enter **System Settings** in the search field (you will see the corresponding icon showing up already during typing of the search string).
 - Open **System Settings** and click on the **Network** icon.
 - Select the physical interface to which you have connected the Ethernet cable (if you have more than one network in the list) and click on **Options**.
 - Select the **IPv4Settings (E)** tab and choose **Manual (F)** in the **Method** drop down box.
 - Click **Add (G)** and enter the IP address **192.168.3.10 (H)** and **255.255.255.0 (I)** as subnet mask and **192.168.3.10 (J)** as gateway.
 - Last, click on **Save (K)** to save these connection settings and close the windows.

You are now ready to test the Ethernet network connection.

3. Click on the **SSH for Target icon (L)** on your desktop. A console window will open and you will see an authentication question. Type **yes** and press Enter.

You are now connected to the target (M). Congratulations!

 If you do not see the user login, check the Ethernet connection between the target and the host. Be sure that you have configured the network adapter in the virtual machine configuration correct.

Your possible next steps

- Read our VM kit manual on the desktop of the VM to learn how to use the advantages of the virtual machine image.
- Check out the product page on the Phyttec website (www.phyttec.eu/phycore-rk3288) for latest documentation, downloads and FAQs or (www.phyttec.de/phycore-rk3288).
- Contact our support team if you have any questions getting the **phyCORE-RK3288** up and running.

Enjoy!

